

-External Screw Bleeder Fitting-

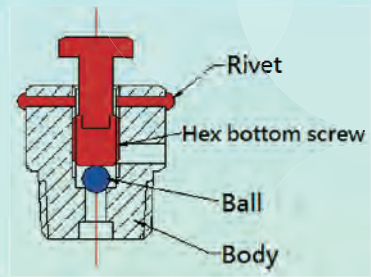

Standard : API 6D
Pressure class : 1000-20000psi



Body material	INCONEL SS316 SS304 4140 A105
Spring	X-750 SS316 SS304
Ball	TC X-750 K500 SS316 SS304
Size	NPT1" NPT3/4" NPT1/2" NPT3/8" NPT1/4" NPT1/8"

-Pipe Threaded Hex Head Plug-

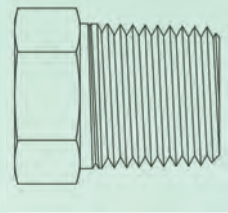

Standard : API 6A , API 6D
Pressure class : 1000-20000psi



Material	INCONEL SS316 SS304 4140 A105
Size	NPT1" NPT3/4" NPT1/2" NPT3/8" NPT1/4" NPT1/8"

Valve Fittings



Products	Materials	Standards
- Grease Fitting	- Inconel	- API 6A
- Single Ball Check Valve	- Monel	- API 6C
- Double Ball Check Valve	- Stainless Steel	- API 6D
- Hex Head Check Valve	- Alloy	
- Drain Fittings	- Carbon Steel	
• All material per customer's requirement		



Website: <http://www.cfmindustries.com/>
Contact: sales2@cfmindustries.com



Website: <http://www.cfmindustries.com/>
Contact: sales2@cfmindustries.com

- Vented Cap Grease Fitting (Standard/Button Head)-

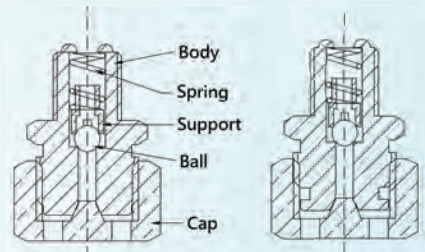

Standard: API 6A,6C Standard: API 6D
Pressure class: 5000-20000psi



Body material	INCONEL SS316 SS304 4140 A105
Spring	X-750 SS316 SS304
Ball	TC X-750 K500 SS316 SS304
Size	NPT1" NPT3/4" NPT1/2" NPT3/8" NPT1/4"

-Combined Grease Fitting-

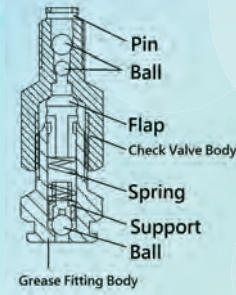

Standard: API 6A , API 6D
Pressure class: 1000-20000psi



Body material	INCONEL SS316 SS304 4140 A105
Spring	X-750 SS316 SS304
Ball	TC X-750 K500 SS316 SS304
Size	NPT1" NPT3/4" NPT1/2" NPT3/8" NPT1/4"

-High Pressure Grease Fitting-

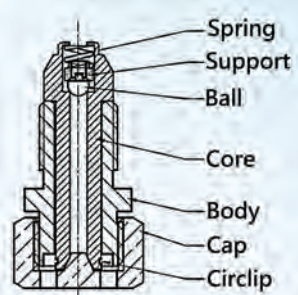

Standard: API 6A , API 6C
Pressure class: 8000-22000psi



Body material	INCONEL SS316 SS304 4140 A105
Spring	X-750 SS316 SS304
Ball	TC X-750 K500 SS316 SS304
Size	UNF14-7/8"

-Injection Fitting-

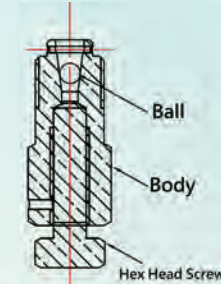

Standard: API 6A
Pressure class: 1000-20000psi



Body material	INCONEL SS316 SS304 4140 A105
Spring	X-750 SS316 SS304
Ball	TC X-750 K500 SS316 SS304
Size	NPT1" NPT3/4" NPT1/2" NPT3/8" NPT1/4"

-Double Ball Grease Fitting-

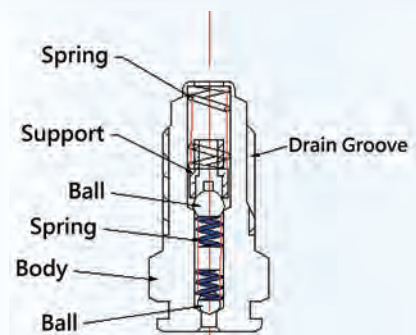

Standard: API 6A , API 6D
Pressure class: 8000-20,000psi



Body material	INCONEL SS316 SS304 4140 A105
Spring	X-750 SS316 SS304
Ball	TC X-750 K500 SS316 SS304
Size	UNF14-7/8" UNF16-3/4" NPT1" NPT3/4" NPT1/2" NPT3/8"

-Check Valve-

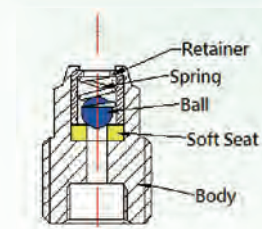

Standard: API 6D
Pressure class: 1000-20000psi



Body material	INCONEL SS316 SS304 4140 A105
Spring	X-750 SS316 SS304
Ball	TC X-750 K500 SS316 SS304
Size	NPT3/4" NPT1/2" NPT3/8" NPT1/4"